

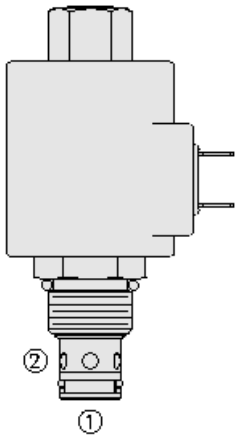

Overview

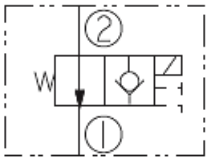

Symbol



Description

A solenoid-operated, 2 way, piloted, poppet-type, normally open, screw in hydraulic cartridge valve designed for low leakage in load-holding applications.

Operation

When de-energized, the SV10-21 allows flow from port 2 to port 1. Flow from port 1 to port 2 is severely restricted in this mode. When energized, the valve's poppet closes on its seat, blocking flow in the port 2 to port 1 direction. In this mode the cartridge will allow port 1 to port 2 flow after overcoming the solenoid force (requires 50 to 150 psi [3.4 to 10.3 bar]).

Features

- Continuous-duty rated coil.
- Hardened seat for long life and low leakage.
- Optional coil voltages and terminations.
- Efficient wet-armature construction.
- Cartridges are voltage interchangeable.
- Unitized, molded coil design.
- Manual override option.
- Optional waterproof E-Coils rated up to IP69K.
- Industry common cavity.

Ratings

Pressure Ratings

Pressure rating	207 bar (3000 psi)	
Proof pressure	344 bar (5000 psi)	
Burst pressure	779 bar (11300 psi)	- Note: (sv10-20)

Flow Ratings

Flow rating	102 lpm (27 gpm)	- Note: Based on
	34.4 bar (500 psi)	- Note: See performance graph
Maximum internal leakage	3 drops/min	- Note: At 207 bar (3000 psi)

Temperature Ratings

Operating fluid temperature	-40 to 100 °C (-40 to 212 °F)	- Note: With buna N seals
	-26 to 204 °C (-15 to 400 °F)	- Note: With fluorocarbon seals
	-54 to 107 °C (-65 to 225 °F)	- Note: With polyurethane seals
Storage temperature	-40 to 70 °C (-40 to 160 °F)	
Ambient temperature	-40 to 70 °C (-40 to 160 °F)	

Operating Parameters

Fluids	Mineral based or synthetic hydraulic fluid with lubricating properties
Fluid viscosity range	7.4 to 420 cSt
Maximum operating contamination level	20/18/14 per ISO 4406

Properties

Unit weight	0.16 kg (0.35 lb)	- Note: Cartridge only
	0.46 kg (1.02 lb)	- Note: Cartridge with e-coil
Internal wetted surface area	210 cm ² (32.5 in ²)	
Materials	continuous from 85% to 115% of nominal voltage	



Performance

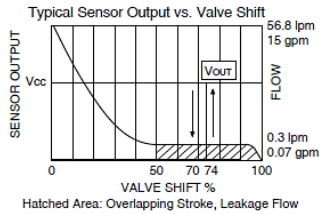
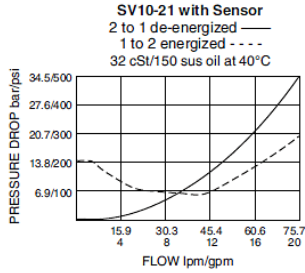
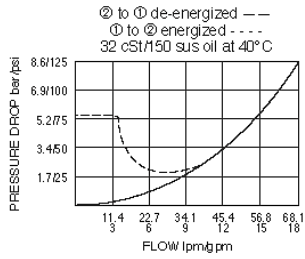

Dimensions

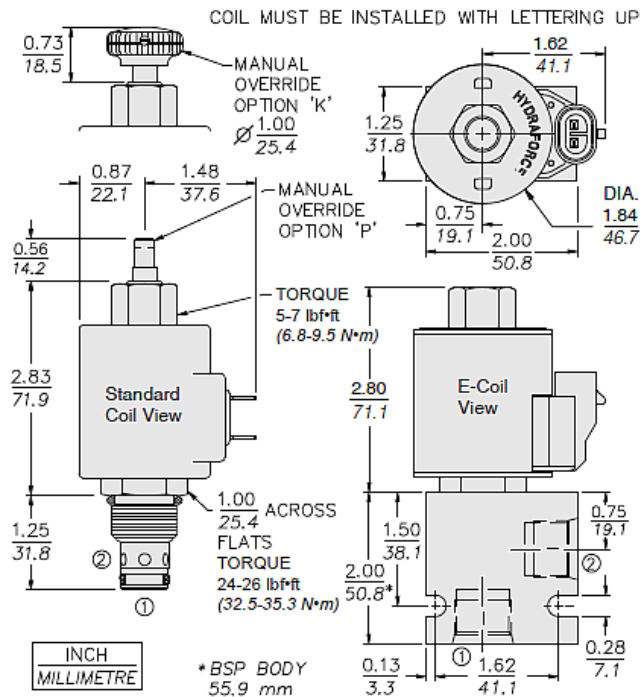

Installation Specifications

Cavity	VC10-2
Cartridge installation torque	32.5 to 35.3 N-m (24 to 26 ft-lb)
Coil nut torque	6.8 to 9.5 N-m (5 to 7 ft-lb)
Orientation restriction	None

Accessories

Seal kit	SK10-2X-T	- Note: (x = seal option)
----------	-----------	---------------------------



Order Code

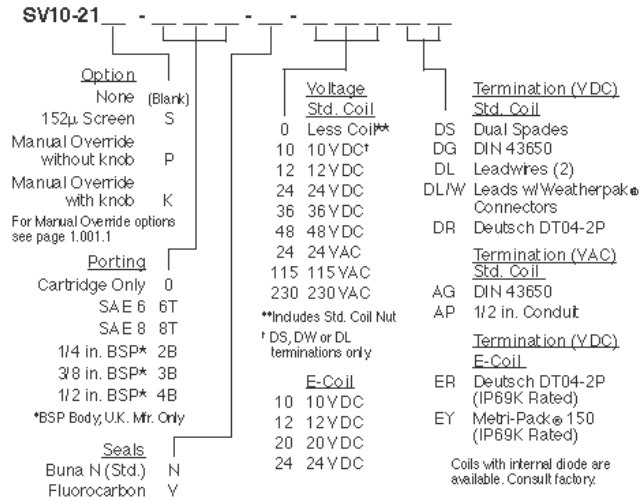

Model Options

SV10-21EG-H-J-L

E Manual Override

CODE	DESCRIPTION
BLANK	NONE
HP	Momentary Push Override, Button with Protective Nut
K	Momentary Push Override, Knob
P	Momentary Push Override, Button

G Screen

CODE	DESCRIPTION
BLANK	NONE
S	100 Mesh Screen

H Line Body

CODE	DESCRIPTION
0	No Body
6T	Aluminum SAE 6
8T	Aluminum SAE 8
6TD	Ductile Iron SAE 6
8TD	Ductile Iron SAE 8
2B	Aluminum BSPP 1/4" (2)
3B	Aluminum BSPP 3/8" (3)
4B	Aluminum BSPP 1/2" (4)
4BD	Ductile Iron BSPP 1/2" (4)

J Seal

CODE	DESCRIPTION
N	Buna-N
V	Fluorocarbon
P	Polyurethane
U	PPDI Urethane

L Coil



CODE	DESCRIPTION
0	No Coil
10DG	10 VDC, D-Coil, DIN 43650
10DL	10 VDC, D-Coil, Dual Lead Wires
10DR/D	10 VDC, D-Coil, Deutsch with Diode
10DS	10 VDC, D-Coil, Dual Spade
10EL	10 VDC, E-Coil, Dual Lead Wires
10ER	10 VDC, E-Coil, Deutsch
10ER/Z	10 VDC, E-Coil, Deutsch with Zener Diode
12DG	12 VDC, D-Coil, DIN 43650
12DL	12 VDC, D-Coil, Dual Lead Wires, 18 inches long
12DL/36	12 VDC, D-Coil, Dual Lead Wires, 36 inches long
12DL/W	12 VDC, D-Coil, Dual Lead Wires with Weatherpak
12DL/W/D	12 VDC, D-Coil, Dual Lead Wires with Weatherpak with Diode
12DR	12 VDC, D-Coil, Deutsch
12DR/D	12 VDC, D-Coil, Deutsch with Diode
12DR/Z	12 VDC, D-Coil, Deutsch with Zener Diode
12DS	12 VDC, D-Coil, Dual Spade
12EG	12 VDC, E-Coil, DIN 43650
12EJ	12 VDC, E-Coil, AMP Jr.
12EL	12 VDC, E-Coil, Dual Lead Wires, 18 inches long
12EL/36	12 VDC, E-Coil, Dual Lead Wires, 36 inches long
12EL/W/Z	12 VDC, E-Coil, Dual Lead Wires with WeatherPak and Zener Diode
12EL/Z	12 VDC, E-Coil, Dual Lead Wires with Zener Diode
12ER	12 VDC, E-Coil, Deutsch
12ER/Z	12 VDC, E-Coil, Deutsch with Zener Diode
12EY	12 VDC, E-Coil, Metri-Pack 150
12EY/Z	12 VDC, E-Coil, Metri-Pack 150 with Zener Diode
20DR/D	20 VDC, D-Coil, Deutsch with Diode
20DS	20 VDC, D-Coil, Dual Spade
20ER	20 VDC, E-Coil, Deutsch
24AG	24 VDC, D-Coil, DIN 43650
24AP	24 VDC, D-Coil, 1/2" Conduit and Dual Lead Wires
24DG	24 VDC, D-Coil, DIN 43650
24DL	24 VDC, D-Coil, Dual Lead Wires
24DL/W	24 VDC, D-Coil, Dual Lead Wires with Weatherpak
24DL/W/D	24 VDC, D-Coil, Dual Lead Wires with Weatherpak with Diode
24DP	24 VDC, D-Coil, 1/2" Conduit and Dual Lead Wires
24DR	24 VDC, D-Coil, Deutsch
24DR/D	24 VDC, D-Coil, Deutsch with Diode
24DS	24 VDC, D-Coil, Dual Spade
24EG	24 VDC, E-Coil, DIN 43650
24EJ	24 VDC, E-Coil, AMP Jr.
24EL	24 VDC, E-Coil, Dual Lead Wires, 18 inches long



CODE	DESCRIPTION
24EL/36	24 VDC, E-Coil, Dual Lead Wires, 36 inches long
24EL/W/Z	24 VDC, E-Coil, Dual Lead Wires with WeatherPak and Zener Diode
24ER	24 VDC, E-Coil, Deutsch
24ER/Z	24 VDC, E-Coil, Deutsch with Zener Diode
24EY	24 VDC, E-Coil, Metri-Pack 150
24EY/Z	24 VDC, E-Coil, Metri-Pack 150 with Zener Diode
36DS	36 VDC, D-Coil, Dual Spade
115AG	115 VAC, D-Coil, DIN 43650
115AP	115 VAC, D-Coil, 1/2" Conduit and Dual Lead Wires
230AG	230 VAC, D-Coil, DIN 43650
230AP	230 VAC, D-Coil, 1/2" Conduit and Dual Lead Wires